

FRAME

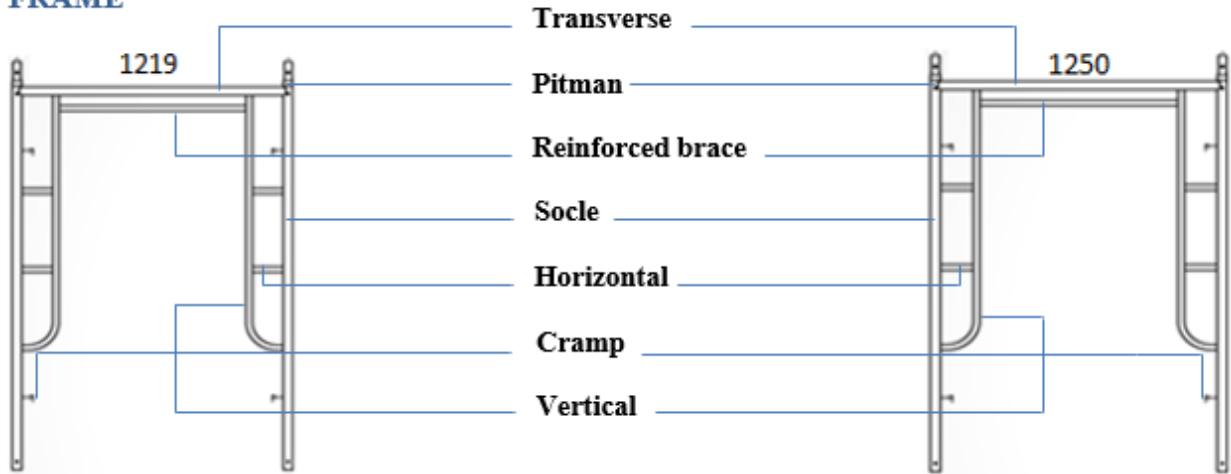

FRAME – Khung giáo				
Product Sản phẩm		Substance Chất liệu	Packing Đóng gói	Remark Ghi chú
Code Mã sản phẩm	Description Quy cách			
SF-W1219H1725-VN	1219*1725mm	SS400/290		
SF-W1250H1700-VN	1250*1700mm			
SF-W1250H1530-VN	1250*1530mm			

SOCLE-Chân chống	GI round tube SS400 $\phi 42.0 \pm 0.25 \text{mm} * 2.0 \pm 0.05 \text{mm} * 1700 \text{mm}$
TRANSVERSE-Thanh ngang	GI round tube SS400 $\phi 42.0 \pm 0.25 \text{mm} * 2.0 \pm 0.05 \text{mm} * 1192 \text{mm}$
REINFORCED BRACE-Thanh gia cố	GI round tube SS400 $\phi 27.2 \pm 0.25 \text{mm} * 1.8 \pm 0.05 \text{mm} * 862 \text{mm}$
VERTICAL-Thanh dọc	GI round tube SS400 $\phi 27.2 \pm 0.25 \text{mm} * 1.8 \pm 0.05 \text{mm} * 1300 \text{mm}$
HORIZONTAL – Thanh bằng	GI round tube SS400 $\phi 27.2 \pm 0.25 \text{mm} * 1.8 \pm 0.05 \text{mm} * 130 \text{mm}$
PITMAN-Đầu nối	GI $\phi 34 * 2.3 \text{t} * 220 \text{mm}$
FLANGE-Chốt chặn	HR round tube SS290 $\phi 42.0 * 3.0 \text{t} * 25 \text{mm}$
CRAMP- Chốt giáo	SS400 $\phi 13 \text{ min} * 53 \text{mm}$

FRAME

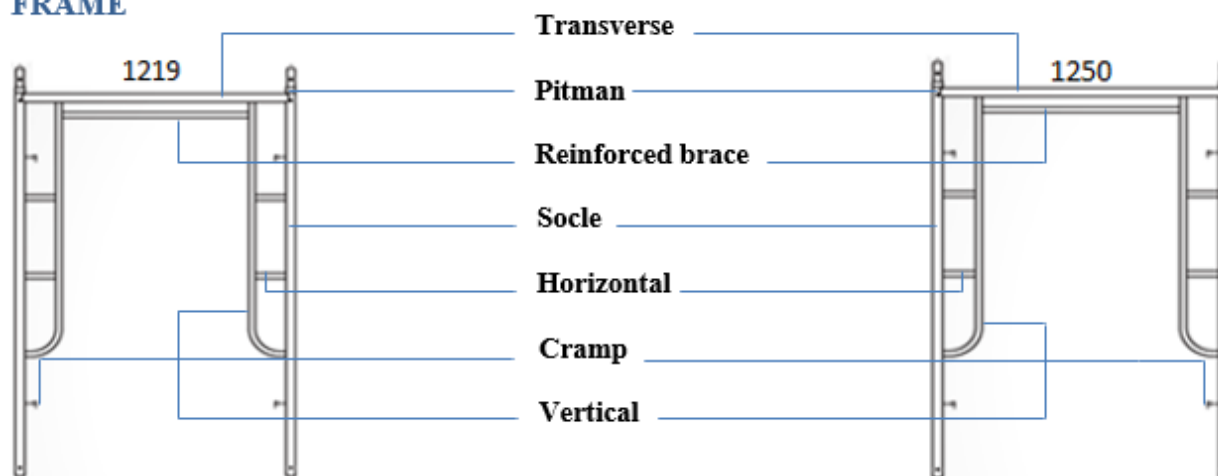

FRAME – Khung giáo				
Product Sản phẩm		Substance Chất liệu	Packing Đóng gói	Remark Ghi chú
Code Mã sản phẩm	Description Quy cách			
SF-W1219H1725-VN	1219*1725mm	SS400/290		
SF-W1250H1700-VN	1250*1700mm			
SF-W1250H1530-VN	1250*1530mm			

SOCLE-Chân chống	GI round tube SS400 $\phi 42.0 \pm 0.25 \text{mm} * 2.0 \pm 0.05 \text{mm} * 1700 \text{mm}$
TRANSVERSE-Thanh ngang	GI round tube SS400 $\phi 42.0 \pm 0.25 \text{mm} * 2.0 \pm 0.05 \text{mm} * 1192 \text{mm}$
REINFORCED BRACE-Thanh gia cố	GI round tube SS400 $\phi 27.2 \pm 0.25 \text{mm} * 1.8 \pm 0.05 \text{mm} * 862 \text{mm}$
VERTICAL-Thanh dọc	GI round tube SS400 $\phi 27.2 \pm 0.25 \text{mm} * 1.8 \pm 0.05 \text{mm} * 1300 \text{mm}$
HORIZONTAL – Thanh bằng	GI round tube SS400 $\phi 27.2 \pm 0.25 \text{mm} * 1.8 \pm 0.05 \text{mm} * 130 \text{mm}$
PITMAN-Đầu nối	GI $\phi 34 * 2.3 \text{t} * 220 \text{mm}$
FLANGE-Chốt chặn	HR round tube SS290 $\phi 42.0 * 3.0 \text{t} * 25 \text{mm}$
CRAMP- Chốt giáo	SS400 $\phi 13 \text{ min} * 53 \text{mm}$

FRAME

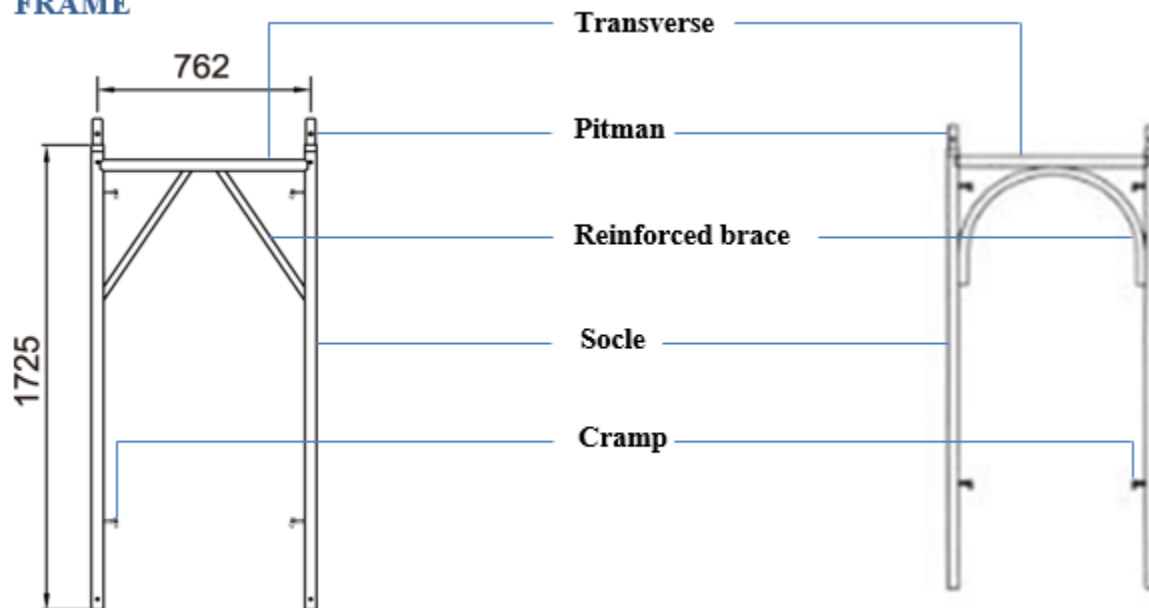

FRAME – Khung chữ bát				
Product Sản phẩm		Substance Chất liệu	Packing Đóng gói	Remark Ghi chú
Code Mã sản phẩm	Description Quy cách			
SF-W762H1725-A	762*1725mm	SS400/290		
SF-W762H1725-B	762*1725mm	SS400/290		

SOCLE-Chân chống	GI round tube SS400 $\phi 42.7 \pm 0.25 \text{mm} * 2.3 \text{t} \pm 0.05 \text{mm} * 1700 \text{mm}$
TRANSVERSE-Thanh ngang	GI round tube SS400 $\phi 42.7 \pm 0.25 \text{mm} * 2.3 \text{t} \pm 0.05 \text{mm} * 739 \text{mm}$
REINFORCED BRACE-Thanh gia cố	GI round tube SS400 $\phi 27.2 \pm 0.25 \text{mm} * 1.8 \text{t} \pm 0.05 \text{mm} * 570 \text{mm}$
PITMAN- Đầu nối	GI $\phi 35 * 2.3 \text{t} * 220 \text{mm}$
FLANGE-Chốt chặn	HR SS290 round tube $\phi 42.5 * 3.5 \text{t} * 25 \text{mm}$
CRAMP-Chốt giáo	SS400 $\phi 13 \text{ min} * 53 \text{mm}$

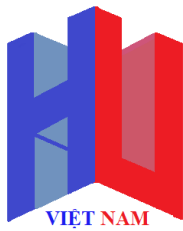

SCAFFOLDING GIÀN GIÁO

COUPLING PIN

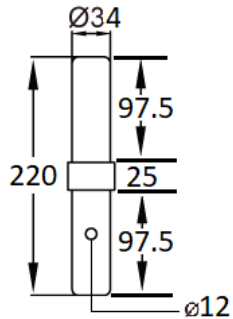

COUPLING PIN – Ống nối				
Product Sản phẩm		Substance Chất liệu	Packing Đóng gói	Remark Ghi chú
Code Mã sản phẩm	Description Quy cách			
PM-L220-VN		SS290		
PITMAN-Thanh liên kết	HR ø35*2.3t*220mm			
FLANGE-Chốt chặn	HR ø42.5*2.3t*25mm			

CROSS BRACE

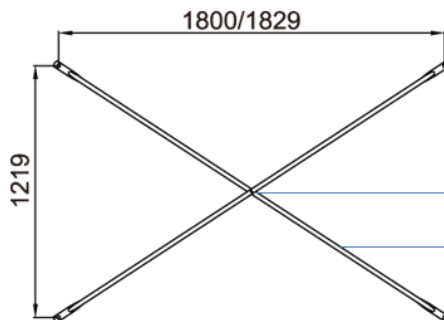

Cramp and washer

Tie robe



COUPLING PIN – Thanh chéo				
Product Sản phẩm		Substance Chất liệu	Packing Đóng gói	Remark Ghi chú
Code Mã sản phẩm	Description Quy cách			
CB-L1998-VN	1800/1829*1219mm	SS400		
TIE ROD-Ống chéo	GI round tube SS400ø21.7±0.25mm*1.95t±0.25mm*2218mm			
CRAMP-Vít nối	SWRM20 ø6.8 min *46.5mm			
WASHER-Long dẹt	Flat type ID ø7.2*OD ø12*t1.0mm			

SCREW JACK

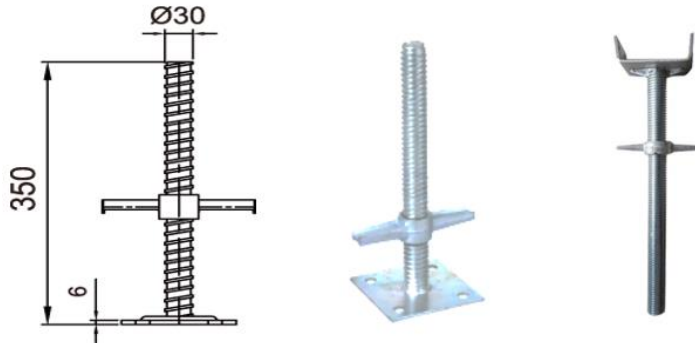

SCREW JACK – Kích chân				
Product Sản phẩm		Substance Chất liệu	Packing Đóng gói	Remark Ghi chú
Code Mã sản phẩm	Description Quy cách			
H300	Ø30*300 mm (Height of base plate excluded)	SS400		
SCREW ROD-Ống ren	SS400 ø30*300mm			
PLATE-Đê	HR SS400 5.4t min *120*120mm			
NUT-Đai kích	FCMB32 ID ø31mm* OD ø45mm			

PIG TAIL PIN

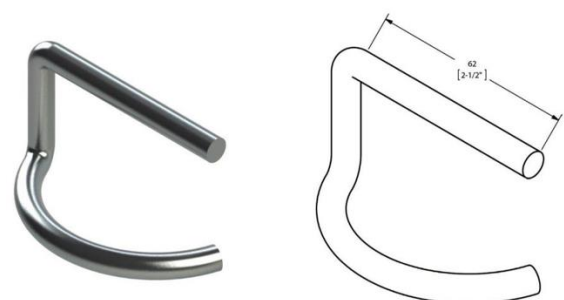

PIG TAIL PIN – Sâu giáo				
Product Sản phẩm		Substance Chất liệu	Packing Đóng gói	Remark Ghi chú
Code Mã sản phẩm	Description Quy cách			
D45		SS400/290		

WALK BOARD

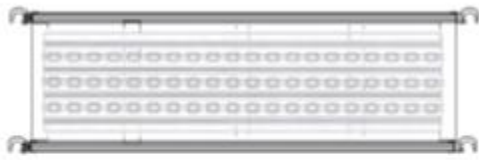

WALK BOARD – Mâm giáo (hai sống)				
Product Sản phẩm		Substance Chất liệu	Packing Đóng gói	Remark Ghi chú
Code Mã sản phẩm	Description Quy cách			
WB-W300L1829-VN-A	300*1829mm	SGCC、SS400	10.5 kg	
WB-W580L1829-VN-A	580*1829mm	SGCC、STK400、SS400	18.5 kg	

PLATE-Thép tấm	SGCC 1.15t*330*1688mm		
TIMBERING-Liệu đỡ	Rectangle tube SS400 20*40*1.35t*1706mm	Round tube SS400 38.1*1.5t*1698mm	
END SOCKET PLATE-Tấm chống xóc	1.8t*95*270mm	1.8t*95*535mm	
REINFORCE PLATE-Tấm gia cố	1.8t*35*277mm	1.15t*75*542mm	
HOOK-Móc mâm	HR SS400 7.2t min *67.5*7.25mm		
BUCKLE-Khóa an toàn	HR SS330 3.2t*36.6*75mm		
RIVET-Đinh vít	Flat end and center cavity $\phi 12*7*17.5$		

